







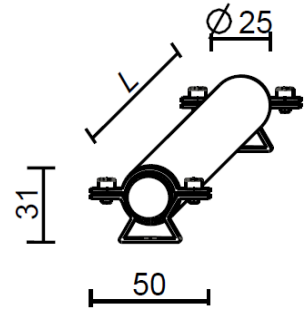
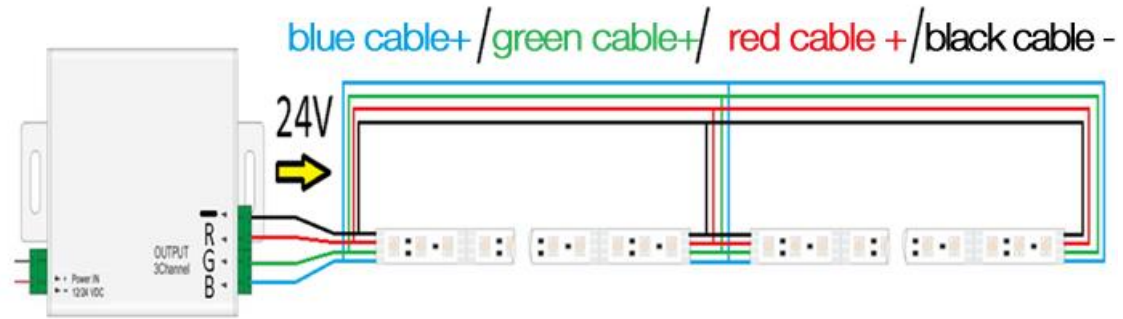

N° LED	Wm	Lm to the light source	Luminous efficiency	Chromatic deviation	CRI	 IP40		R / V / B		
60	14,4	- 360 -	-	-	-	Not protected against the ingress of liquids	Diffuse	-	RGB	- - -
84	17,1	- 418 -	-	-	-	Not protected against the ingress of liquids	Diffuse	-	RGB	- - -

Model	Description	Dimensions 50 x 31 x L mm
	On wall/ceiling/floor Shield Led Bar, maximum size 50mm X 31mm. Finish: grey anodized aluminum, other colors on request. Protection screen: transparent polycarbonate. It is provided with 1m bipolar neoprene cable for the electrical connection. Maximum length 1150mm. Indoor/outdoor installation on any rigid surface by suitable brackets. Fixing with screws suitable to the support with 6mm diameter, not supplied by us.	

ELECTRICITY SUPPLY: 24V parallel electrical connection SELV POWER SUPPLY, not included, remotely placed	Connection: Connector compliant with EN 60998-2-1
24Vdc RGB parallel electrical connection by pilot module. POLARITY: RED cable + BLACK cable -	<p>ATTENTION</p> <p>The protection degree of the connection system must be identical or greater than the protection degree of the product.</p> <p>The junction clips are not included. The installation must be carried out by qualified Personnel.</p>
	

ATTENTION: Before starting all electrical connections, make sure that the power supply is not powered. The connection to the electricity grid must be carried out only after completing the wiring of all the components. If this simply rule is not respected, the lighting source will be irretrievably damaged. The installation must be carried out by qualified personnel.

 Compliant with European standards EMC – RoHS – REACH - Ecodesign	 It must not be provided with a electrical ground of protection	DIMMABLE By dimmable power supply	OPERATING TEMPERATURE -20°C +40°C	 Separate waste collection of electric and electronic equipment	Made in Italy Projected, manufactured and assembled in Italy
--	---	--	---	---	--

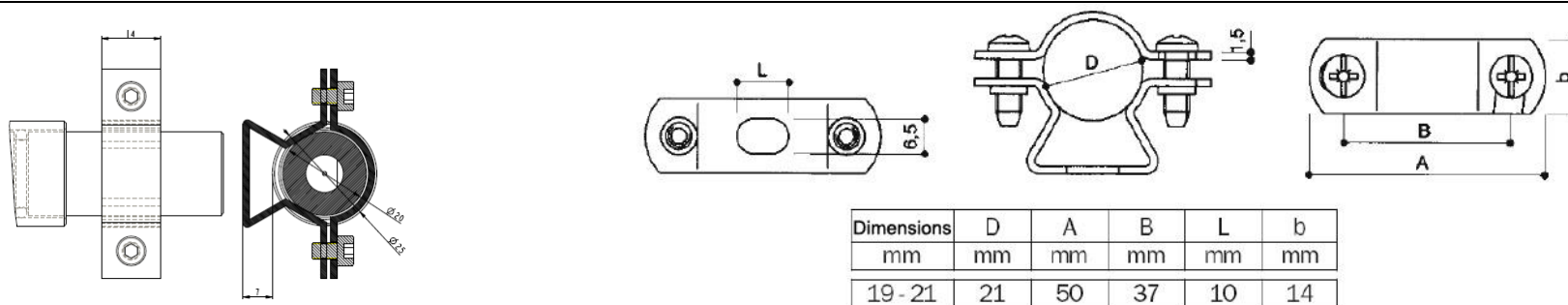

WARNING AND PROVISIONS

ATTENTION!

The appliance safety is guaranteed only by respecting, both during installation and employment phase, of the following instructions. It is therefore necessary to archive the present document.

WARNINGS:

- The power supply voltage must be removed during the installation and during any operation.
- The appliance must not be modified or tampered with in any way. Every modification can compromise the safety of the appliance, making it dangerous. Hi.Project srl refuses any responsibility for modified or tampered with products. Modifications or tampering with the product, if not authorized by the company (Hi.Project s.r.l.), nullify any direct and indirect responsibility of the manufacturer as well as the warranty.
- The appliance is free from the photobiological risk. Please follow the instructions of this data sheet.
- The product is to be considered a "Containing Product" and is not subject to maintenance. The light source can only be replaced by the manufacturer. For further information please contact Hi.Project s.r.l.
- If the flexible power cable is damaged, it can be substituted only by the manufacturer. For further information please contact Hi.Project s.r.l.
- Each product, at the end of its life, must be committed to a waste storage center specialized in electrical and electronic equipment. Alternatively, it can be returned to the manufacturer.

WARRANTY CONDITIONS:

Our products are guaranteed for 24 months from the date of purchase. The warranty only covers construction defects attributable to the manufacturer. The warranty does not include all the activities necessary for the product to arrive free port at the manufacturer for repair.

The warranty is void if the malfunction is due to: improper use of the product, tampering, repairs not authorized by Hi. Project S.r.l., negligence of the installer, failure to comply with the product rating plate, damage due to natural causes such as lightning or power surges, use of power supplies or drivers not approved by Hi. Project S.r.l. and/or in any case not compliant with the technical regulations that regulate the European market, damage caused by wrong connections or connections with an IP degree lower than the purchased product, damage caused during the transport (even if the transport is organized by Hi. Project S.r.l. on behalf of the Customer), other causes that are not expressly and unequivocally referred to the defectiveness of the product itself.

PRODUCT CLEANING INSTRUCTIONS

- To clean the appliance, use exclusively a soft cloth, possibly moistened with water and neutral soap.
- Warning: do not use aggressive cleansers, alcohol or solvents.

The information contained in this document may be changed by Hi.Project s.r.l. at any time without notice and does not imply the assumption, even implicit, of any obligation on the part of Hi. Project Srl.

Hi. Project Srl refuses all responsibility if the installation is not carried out by qualified personnel and in compliance with current regulations.

84 led/m Led
17,1 W/m RGB

